

 **breviglieri**

# POWER HARROWS

ERPICI ROTANTI

HERSES ROTATIVES

KREISELEGEN

GRADAS ROTATIVAS



 **breviglieri**

Uomini, idee, macchine.





# The range

Available for tractors from 30 up to 260 HP

- I Disponibili per trattori da 30 a 260 cv
- F Disponibles pour tracteurs de 30 à 260 cv
- D Verfügbar für Traktoren von 30 bis 260 PS
- E Disponibles para tractores de 30 a 260 cv

I La gamma F La gamme D Die Auswahl E La gama

## Mekfarmer 80



**30 - 80 HP**

cm. 110 - 130 - 150 - 170 - 190

## Mekfarmer 100



**60 - 100 HP**

cm. 200 - 230 - 250 - 300



## Mekfarmer 120



**90 - 120 HP**  
cm. 250 - 300 - 350

## Mekfarmer 150



**90 - 150 HP**  
cm. 250 - 300 - 350

## Mekfarmer 170



**100 - 170 HP**  
cm. 300 - 350 - 400

## Mekfarmer 220



**140 - 220 HP**  
cm. 300 - 350 - 400 - 450



## Mekfarmer K180



**100 - 180 HP**  
cm. 300 - 350 - 400

## Mekfarmer K230



**140 - 230 HP**  
cm. 300 - 350 - 400 - 450

## Mekfarmer K270



**150 - 270 HP**  
cm. 300 - 350 - 400 - 450





## BALL BEARINGS

- 1 Cuscinetti a sfera F Roulements à billes
- 2 Kugellager E Cojinetes a esferas

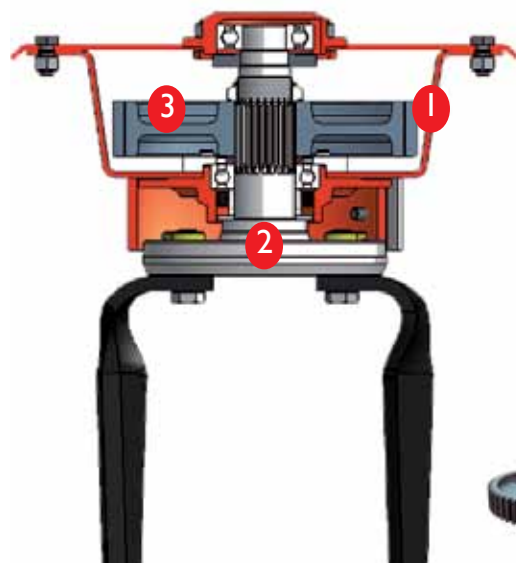

## TAPERED ROLLER BEARINGS

- 1 Cuscinetti conici F Roulements coniques
- 2 Konische Lagerungen E Cojinetes cónicos

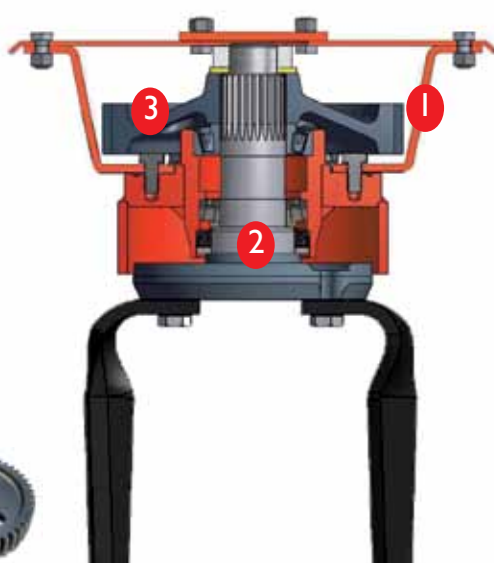

## SPECIAL MOUNTING OF BLADES

- 1 Fasatura coltelli F Décalage des couteaux D Zinken E Montaje special cuchillas

This system to assembly the blades allows:

- 1 Questo particolare sistema di montaggio dei coltelli consente:
- 2 Ce système spécial de montage des lames permet de:
- 3 Dieses spezielle Zinkenmontagesystem erlaubt:
- 4 Este sistema de montaje de las cuchillas permite de:

- 1 To eliminate the vibrations
- 2 Eliminare le vibrazioni
- 3 Éliminer les vibrations
- 4 Die Vibrationen zu entfernen
- 5 Eliminar las vibraciones

- 2 To reduce the absorption of power and a saving fuel consumption

- 1 Ridurre l'assorbimento di potenza e consumi di carburante
- 2 Réduire l'absorption de puissance et consommations de carburant
- 3 Die Absorption der Kraft und des Treibstoffverbrauchs zu verringern
- 4 Reducir la absorción de potencia y consumos de carburante

- 3 Fine clods for a perfect seeded

- 1 Zolle fini per una perfetta semina
- 2 Des mottes fines pour une parfaite semée
- 3 Dünne Scholle für eine perfekte Aussaat
- 4 Terrones finos para una perfecta siembra

## SIDE SHIELDS

- 1 Deflettori laterali F Déflécteurs latéraux D Seitenschilder E Deflectores laterales

standard: MekFarmer 80



standard: MekFarmer 100



standard: MekFarmer 120  
MekFarmer 150  
MekFarmer 170  
MekFarmer 220  
MekFarmer K 180  
MekFarmer K 230  
MekFarmer K 270



standard: MekFarmer 120  
MekFarmer 150  
MekFarmer 170  
MekFarmer 220  
MekFarmer K 180  
MekFarmer K 230  
MekFarmer K 270



MOD.	1	2	3	MOD.	1	2	3	MOD.	1	2	3
Mekfarmer 80	mm 3	mm 45	40	Mekfarmer 150	mm 5	mm 50	48	Mekfarmer K180	mm 7+7	mm 55	40
Mekfarmer 100	mm 5	mm 45	40	Mekfarmer 170	mm 7	mm 50	48	Mekfarmer K230	mm 7+7	mm 55	40
Mekfarmer 120	mm 5	mm 50	48	Mekfarmer 220	mm 7	mm 50	48	Mekfarmer K270	mm 7+7	mm 55	40

- 1 Flat-pan thickness steel
- 2 Spessore lamiera vasca
- 3 Epaisseur tôle
- 4 Dick des Bleches der Wanne
- 5 Espesor plancha
- 6 Side blade holder shaft diam.
- 7 Diametro albero portadente laterale
- 8 Diamètre arbre porte dent latéral
- 9 Seitliche Zinkenträger durchmesser
- 10 Diametro eje porta-diente central
- 11 Nr. tines gear transmission
- 12 N° denti ingranaggio di trasmissione
- 13 Nombre dents engrange
- 14 Nr. der Zahnen der Antriebszahnäder
- 15 Nr. dientes engranje de transmisión

## SUPERFAST

Without tools! Without effort!

- 1 Senza attrezzi! Senza fatica!
- 2 Sans outils! Sans fatigue!
- 3 Ohne Werkzeug! Ohne Mühe!
- 4 Sin las herramientas! Sin esfuerzo!

The BREVIGLIERI system in order to replace blades in a moment

- 1 Il sistema Breviglieri per sostituire gli utensili in un attimo
- 2 Le système BREVIGLIERI pour changer les outils dans un seul instant
- 3 Das BREVIGLIERI System für di Werkzeuge sofort zu ersetzen
- 4 El sistema BREVIGLIERI para substituir las cuchillas en un momento

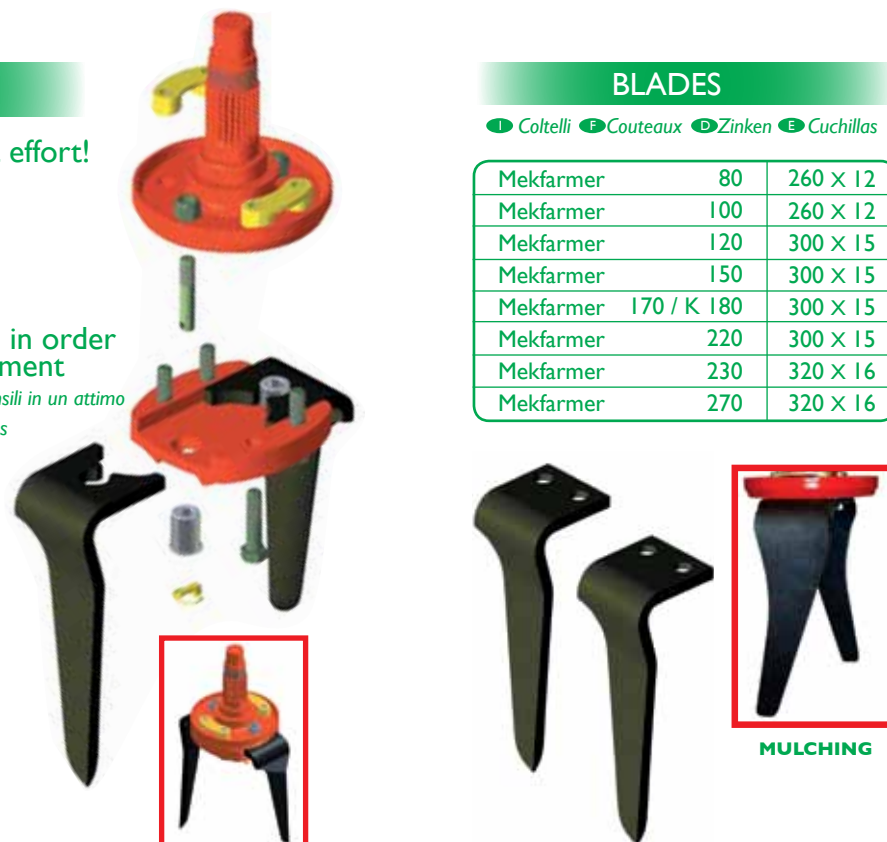

MULCHING

## AVAILABLE ON

- 1 Disponibile
  - 2 Disponible
  - 3 Verfügbar
  - 4 Disponible
- Mekfarmer 150 - 170 - 220 - K180 - K230 - K270





## REAR ROLLERS

1 Rulli posteriori 2 Rouleaux arrière 3 Hintere Walzen 4 Rodillos posteriores



Spiked roller (Ø 477-525) (Ø 102-164)  
 1 Rullo dentato  
 2 Rouleau à dents  
 3 Zinkenwalze  
 4 Rodillo a dientes



Cage roller (Ø 370-405-450-500)  
 1 Rullo gabbia  
 2 Rouleau cage  
 3 Stabwalze  
 4 Rodillo jola



Packer roller (Ø 406-464-500-550)  
 1 Rullo packer  
 2 Rouleau packer  
 3 Zahnpackerwalze  
 4 Rodillo packer



Spiked roller maxi (Ø 525) (Ø 273)  
 1 Rullo dentato maxi  
 2 Rouleau à dents maxi  
 3 Zinkenwalze maxi  
 4 Rodillo dentado maxi



Crumbling roller (Ø 412-500)  
 1 Rullo sminuzzatore  
 2 Rouleau emoteur  
 3 Krummenpackerwalze  
 4 Rodillo desmenuzador



Spiral roller (Ø 460)  
 1 Rullo spirale  
 2 Rouleau spire  
 3 Spiralwalze  
 4 Rodillo espiral

## ROLLERS ADJUSTEMENT

1 Regolazione rulli 2 Réglage rouleaux 3 Walzenverstellung 4 Ajuste rodillos



STANDARD  
 With pins  
 1 A perni  
 2 Par tourillons  
 3 Mit Spindel  
 4 A pernos



OPTION  
 Mechanical jacks (2)  
 1 Martinetti meccanici (2)  
 2 Vérins mécaniques (2)  
 3 Mit Bolzen (2)  
 4 Con tornillos (2)



OPTION  
 Hydraulic jacks (2)  
 1 Martinetti idraulico (2)  
 2 Vérins hydraulique (2)  
 3 Hydraulische Zylinder (2)  
 4 Cilindro hidráulico (2)

## PTO SHAFT

1 Cardano 2 Cardan 3 Gelenkwille 4 Cardan



With shear bolt  
 1 Con limitatore a bulloni  
 2 Avec limiteurs à boulons  
 3 Mit Scherstift  
 4 Con limitador a bulón

STANDARD  
 Mekfarmer 80-100



With slip clutch  
 1 Con frizione a dischi  
 2 Avec sécurité à disques  
 3 Rutschkupplung  
 4 Con embragues de discos

STANDARD  
 Mekfarmer 120-150-170-220  
 Mekfarmer K180-K230-K270

OPTION  
 Mekfarmer 80-100



With cam clutch  
 1 Con sicurezza automatica  
 2 Avec sécurité à came  
 3 Mit Nockenschaltkupplung  
 4 Con embrague de seguridad

OPTION  
 Mekfarmer 120-150-170-220  
 Mekfarmer K180-K230-K270

## HYDRAULIC SEEDER LINKAGE

1 Attacco idraulico seminatrici  
 2 Attelage hydraulique semair  
 3 Hydraulische Drillmaschinenanbauteile  
 4 Enganche hidráulico sembradora



MAX LOAD KG 2000

## BACK REFLEX PANELS



1 Pannelli retroriflettenti  
 2 Panneaux de signalisation  
 3 Erkennungstafel  
 4 Paneles retroreflejantes

OPTION  
 Mekfarmer 120-150  
 170-220  
 Mekfarmer K180  
 K230-K270

## STONE PROTECTION

1 Protezione sassi  
 2 Protéctions cailloux  
 3 Wickel Steinschutz  
 4 Protección piedras



STANDARD  
 Mekfarmer 150-170-220  
 Mekfarmer K180-K230-K270

OPTION  
 Mekfarmer 80-100-120

## REAR PTO

1 PDF Posteriore  
 2 PDF arrière  
 3 Hinter Durchtrieb  
 4 Toma de fuerza posterior



STANDARD  
 Mekfarmer 150-170-220  
 Mekfarmer K180-K230-K270

OPTION  
 Mekfarmer 100-120

## RIGID TRACK ERADICATOR

Ancora rompitraccia  
 1 Effaceur de trace  
 2 Spurlockerer  
 3 Eliminador de rostro



OPTION  
 Mekfarmer 80-100-120-150-170-220  
 Mekfarmer K180-K230-K270

## REAR LEVELLING BAR

1 Barra livellatrice posteriore  
 2 Barre niveleuse arrière  
 3 Hintere Planierschiene  
 4 Barra niveladora trasera













STANDARD  
 Mekfarmer 100-120-150-170-220  
 Mekfarmer K180-K230-K270

OPTION  
 Mekfarmer 80

				540 RPM	1000 RPM	Cod.	
Mekfarmer 80	-	-	324	-	-	8201423	standard
	19	21	293	-	-	8201423	option
	21	19	358	-	-	8201427	
	18	22	265	-	-	8201427	
Mekfarmer 100 - 120	22	18	396	-	-	-	standard
	17	16	311	-	-	8201424	
	16	17	275	-	-	8201428	
	18	15	351	-	-	8201428	
	15	18	244	-	-	8201429	
Mekfarmer 150	12	21	-	309	-	8201430	option
	13	20	-	352	-	8201430	
	32	24	348	-	-	8066254	
	24	32	-	362	-	8066256	
	30	26	301	-	-	8066257	
Mekfarmer 170 / K 180	33	23	374	-	-	8066258	option
	25	31	-	389	-	8066258	
	22	34	-	312	-	8066259	
	26	35	-	359	-	8066239	
	35	26	350	-	-	8066232	
	21	40	-	253	-	8066233	
	23	38	-	292	-	8066233	
	38	23	430	-	-	8066234	
	24	37	-	313	-	8066234	
	37	24	402	-	-	8066235	
	25	36	-	335	-	8066235	
	36	25	375	-	-	8066236	
27	34	207	383	-	8066236		
34	27	328	-	-	8066237		
28	33	221	410	-	8066237		
33	28	307	-	-	8066238		
29	32	236	438	-	8066238		
32	29	288	-	-	8201426		
Mekfarmer 220 / K 230	18	19	-	332	-	8201426	standard
	19	18	-	371	-	8201433	
	16	21	-	267	-	8201433	
	21	16	-	461	-	8201434	
	17	20	-	298	-	8201434	
Mekfarmer K 270	20	17	-	413	-	8066462	option
	30	39	-	365	-	8066462	
	23	46	-	238	-	8066460	
	27	43	-	298	-	8066461	
33	36	-	435	-	8066463		

# Technical data

DATI TECNICI / DONNÉES TECHNIQUES / TECHNISCHE DATEN / DATOS TECNICOS

																					
			Mod. Mekfarmer	HP			rpm	cm	cm	n.	cm	KG	KG	KG	KG	KG	KG	KG	KG	KG	KG
								Ø 477 1	Ø 525 2	Ø 525 3	Ø 405 x MekFarmer 80 Ø 370	Ø 450	Ø 500	Ø 460	Ø 412	Ø 500	Ø 406	Ø 464	Ø 500	Ø 550	
<b>80-110</b>	30-44	540		110	113	10	8-27	340			308						342				
<b>80-130</b>	40-50	540		130	133	12	8-27	375			338						396				
<b>80-150</b>	50-60	540		150	153	14	8-27	410			368						450				
<b>80-170</b>	60-80	540		170	173	16	8-27	445			398						504				
<b>80-190</b>	70-80	540		190	193	18	8-27	480			428						558				
<b>100-200</b>	60-70	540	1000	200	205	20	8-27	680			670	700		690	680		780	810			
<b>100-230</b>	65-80	540	1000	230	235	22	8-27	730			700	730		720	710		830	860			
<b>100-250</b>	70-90	540	1000	250	255	24	8-27	780			750	780		770	760		880	910			
<b>100-300</b>	80-100	540	1000	295	300	28	8-27	880			850	880		870	860		980	1010			
<b>120-250</b>	90-110	540	1000	250	255	20	10-30		935	980		910		910	880	950		1110	1180	1250	
<b>120-300</b>	100-120	540	1000	295	300	24	10-30		1092	1137		1100	1200	1100	1070	1140		1195	1265	1335	
<b>120-350</b>	100-120	540	1000	345	350	28	10-30		1192	1237		1200	1300	1200	1170	1240		1295	1365	1435	
<b>150-250</b>	90-120	540	1000	243	252	20	10-30		1092	1138		1102		1102	1072	1142		1242	1312	1382	
<b>150-300</b>	110-140	540	1000	288	300	24	10-30		1212	1258		1223	1323	1220	1183	1253		1362	1432	1502	
<b>150-350</b>	120-150	540	1000	345	350	28	10-30		1282	1328		1293	1393	1290	1253	1323		1432	1502	1572	
<b>170 - 300 K180</b>	100-130	540	1000	295	300	24	10-30		1190	1236		1220	1320	1223	1180	1250		1420	1472	1552	
<b>170 - 350 K180</b>	110-150	540	1000	345	350	28	10-30		1330	1376		1360	1460	1360	1320	1390		1570	1640		
<b>170 - 400 K180</b>	120-170	540	1000	395	400	32	10-30		1470	1516		1500	1600	1500	1460	1530		1710	1780		
<b>220-300</b>	140-160		1000	295	300	24	10-30		1255	1301		1285	1385	1285	1245	1315		1450	1500	1570	
<b>220-350</b>	150-170		1000	345	350	28	10-30		1400	1446		1430	1530	1430	1390	1460		1640	1730		
<b>220-400</b>	170-200		1000	395	400	32	10-30		1550	1596		1580	1680	1580	1540	1610		1790	1860		
<b>220-450</b>	180-220		1000	445	450	36	10-30		1700			1730	1830	1730	1690	1760		1940	2010		
<b>K 230-300</b>	140-160		1000	295	300	24	10-32		1255	1301		1285	1385	1285	1245	1315		1450	1500	1570	
<b>K 230-350</b>	150-170		1000	345	350	28	10-32		1400	1446		1430	1530	1430	1390	1460		1640	1730		
<b>K 230-400</b>	170-200		1000	395	400	32	10-32		1550	1596		1580	1680	1580	1540	1610		1790	1860		
<b>K 230-450</b>	180-230		1000	445	450	36	10-32		1700			1730	1830	1730	1690	1760		1940	2010		
<b>K 270-300</b>	150-180		1000	295	300	24	10-32		1550	1595		1590	1690	1590	1550	1620		1730	1790	18060	
<b>K 270-350</b>	150-200		1000	345	350	28	10-32		1710	1750		1700	1760	1760	1720	1810		1900	2010		
<b>K 270-400</b>	160-230		1000	395	400	32	10-32		1935	1926		1900	2000	1900	1860	1930		2110	2180		
<b>K 270-450</b>	180-270		1000	445	450	36	10-32					2060	2160	2060	2020	2090		2270	2340		

- 1** Tubo centrale Ø 102 (Ø 477)    **GB** Central tube Ø 102 (Ø 477)    **F** Tuyau centrale Ø 102 (Ø 477)    **D** Zentral Rohr Ø 102 (Ø 477)    **E** Tubo central Ø 102 (Ø 477)  
**2** Tubo centrale Ø 164 (Ø 525)    Central tube Ø 164 (Ø 525)    Tuyau centrale Ø 164 (Ø 525)    Zentral Rohr Ø 164 (Ø 525)    Tubo central Ø 164 (Ø 525)  
**3** Tubo centrale Ø 273 (Ø 525)    Central tube Ø 273 (Ø 525)    Tuyau centrale Ø 273 (Ø 525)    Zentral Rohr Ø 273 (Ø 525)    Tubo central Ø 273 (Ø 525)

